

FCS-G1/4A4-NA-H1141

Flow Monitoring – Immersion Sensor without Integrated Processor

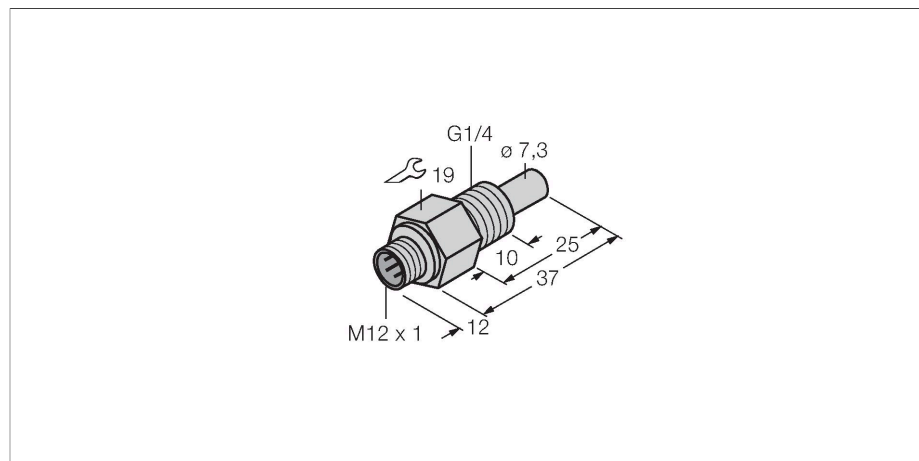

Features

- Sensor for liquid media
- Calorimetric functionality
- Adjustment via signal processor
- Status indicated via LED chain on signal processor
- Connector device, M12 × 1
- 4-wire connection to the processor

Wiring diagram

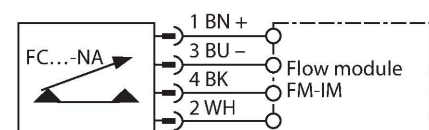

Technical data

ID no.	6870304
Type	FCS-G1/4A4-NA-H1141
Mounting	Immersion sensor
Water Operating Range	1...150 cm/s
Oil Operating Range	3...300 cm/s
Stand-by time	typ. 8 s (2... 15 s)
Switch-on time	typ. 2 s (1... 15 s)
Switch-off time	typ. 2 s (1... 15 s)
Temperature jump, response time	max. 12 s
Temperature gradient	≤ 250 K/min
Medium temperature	-20...+80 °C
Protection class	IP67
Design	Immersion
Housing material	Stainless steel, 1.4571 (AISI 316Ti)
Sensor material	Stainless steel, 1.4571 (AISI 316Ti)
Max. tightening torque of housing nut	30 Nm
Electrical connection	Connector, M12 × 1
Process Pressure	100 bar
Process connection	G 1/4"

Functional principle

Our insertion - flow sensors operate on the principle of thermodynamics. The measuring probe is heated by several °C as against the flow medium. When fluid moves along the probe, the heat generated in the probe is dissipated. The resulting temperature is measured and compared to the medium temperature. The flow status of every medium can be derived from the evaluated temperature difference. Thus TURCK's wear-free flow sensors reliably monitor the flow of gaseous and liquid media.